

HYVA ALUMINIUM OIL TANKS



SIDE MOUNTED TANK

Hyva

type :

SM - 179L/150L - AL - MP - MR

Page 1 / 1

part number tank :

140 18 228

working volume :

150 liters

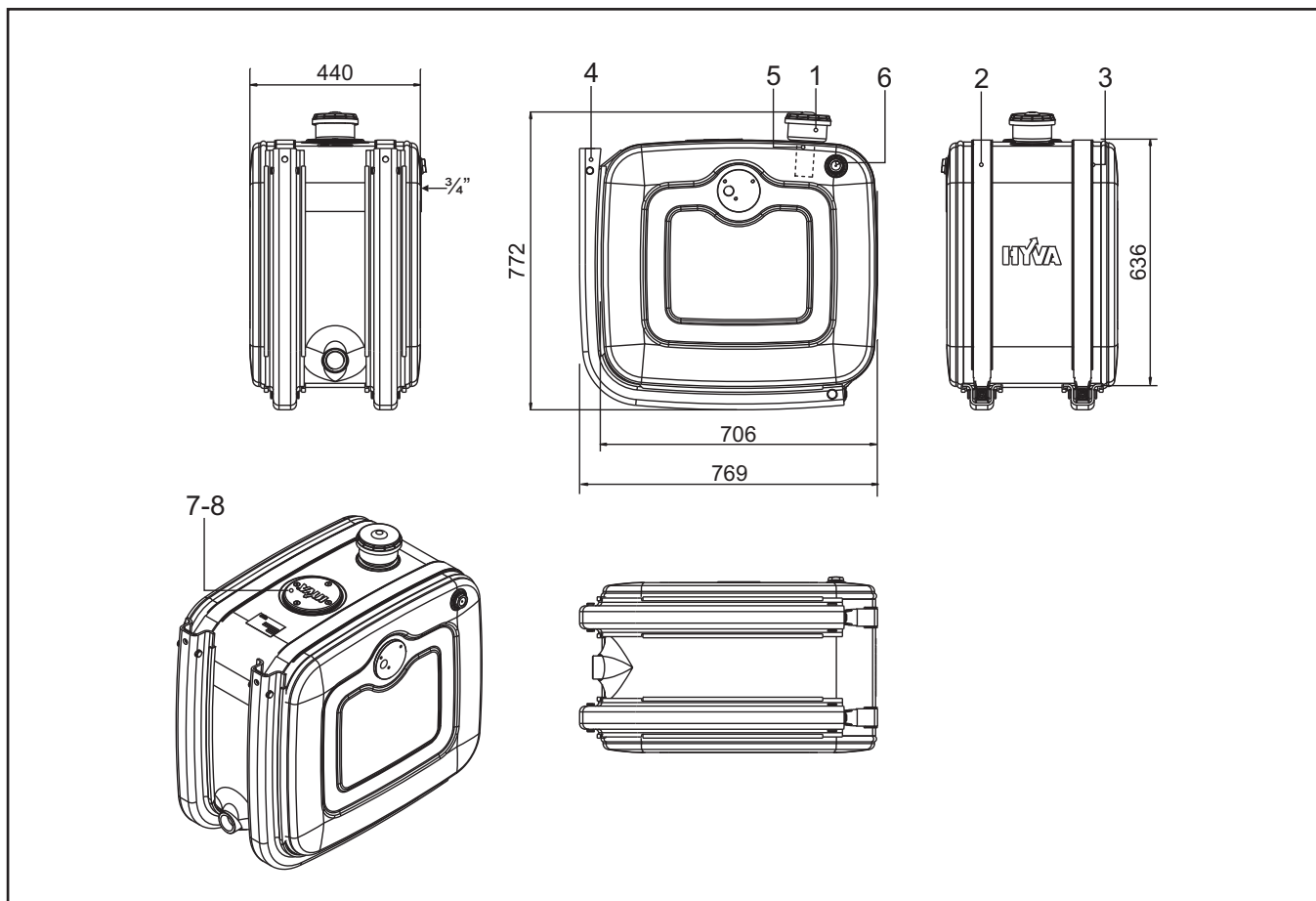

Part list

Pos.	Part no.	Description	Qty.
	140 20 161	Mounting kit parts consisting of:	
1	081 02 116	air breather filter	1
2	140 20 300	straps	2
3	140 20 328	kit for two supports	1
4	140 20 321	tank support	2

Spare Parts

Pos.	Part no.	Description	Qty.
5	081 02 117	air filter element	1
6	081 02 121	spy glass	1
7	020 52 431	cover plate	1
8	020 52 432	gasket	1

Optional part

Part no.	Description	Qty.
147 80 303	return filter kit	1

General information

Pay attention to the following points:

- Mount the tank according to the mounting instructions.
- Fill the tank with the recommended hydraulic oil to the centre of the spy glass (level indicator).
- Change the oil once a year.
- Replace the air breather filter twice a year.
- Do not use the tank as a support or to stand on.
- Do not weld to the oil tank.

Specifications

Gross volume	: 179	Liters
Fill volume	: 165	Liters
Working volume	: 150	Liters
Weight tank	: 16	kg
Weight each support	: 10	kg
Connections	: 1½"	BSPIT (Suction)
	: ¾"	BSPIT (Valve plate)